

Figure 1
the pushpoint sampler

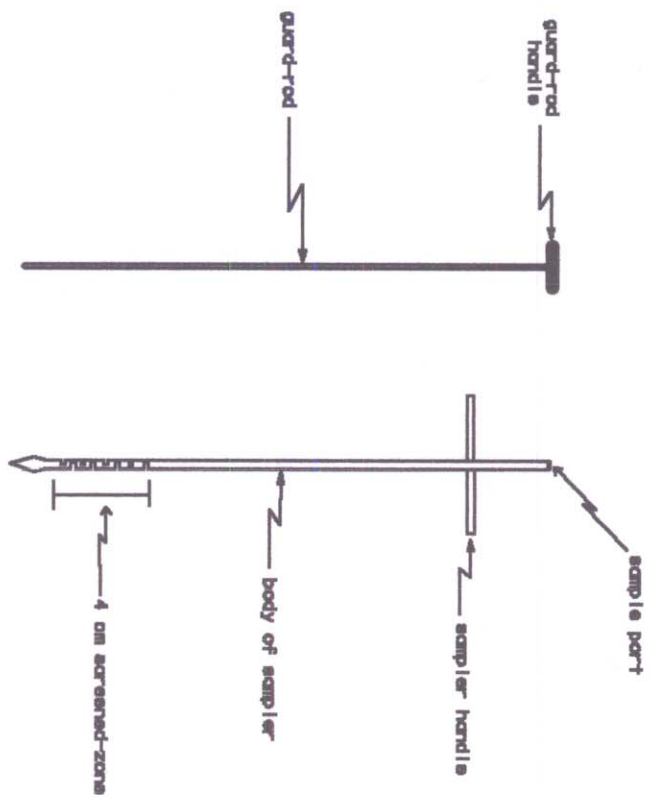

Fig. 1a
disassembled sampler

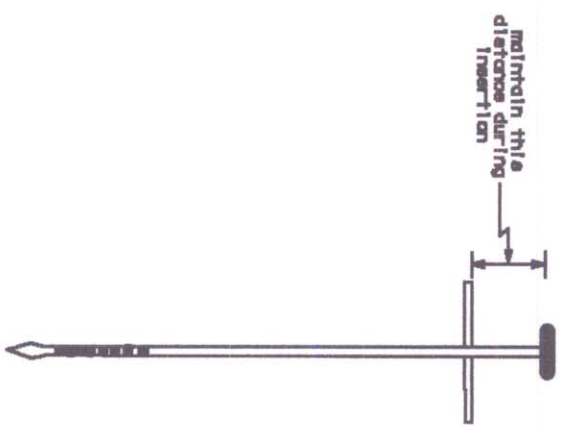

Fig. 1b
assembled sampler

Figure 2

grasp instrument firmly
and squeeze two handles
together to maintain
this distance while
inserting into sediments

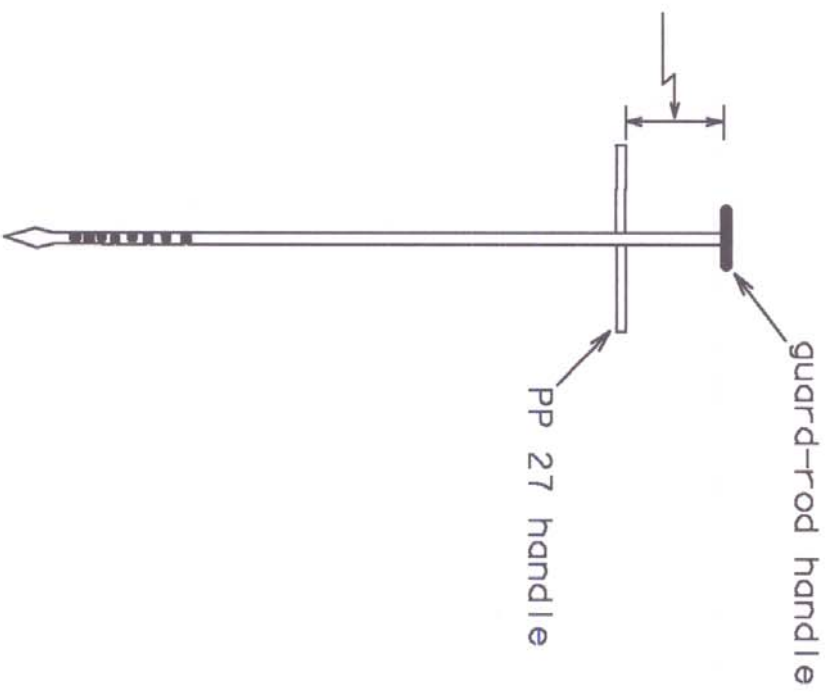

Figure 3

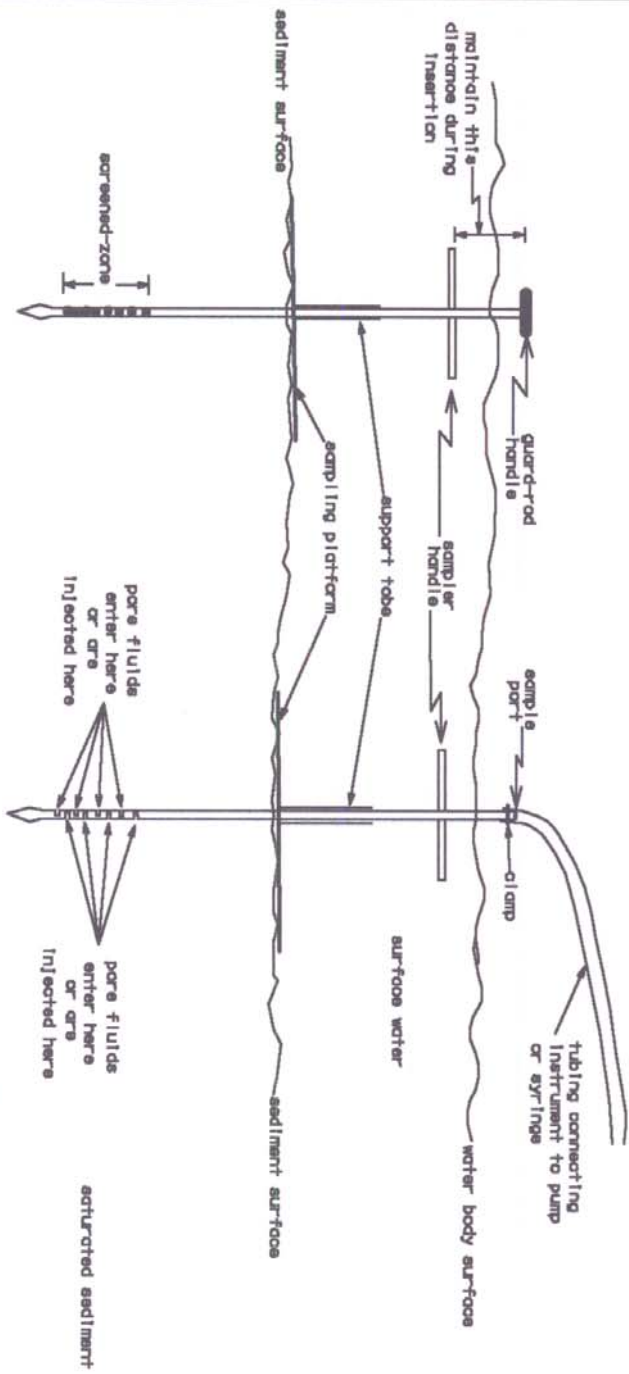
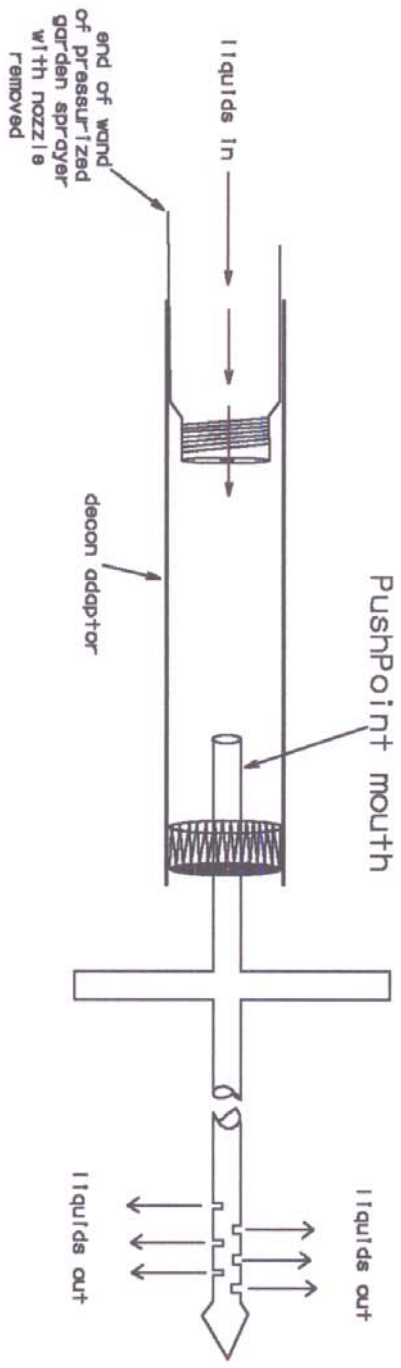

Fig. 3a
configuration when
installing in sediments

Fig. 3b
configuration while
sampling groundwater

Figure 4

attachment of decon adaptor



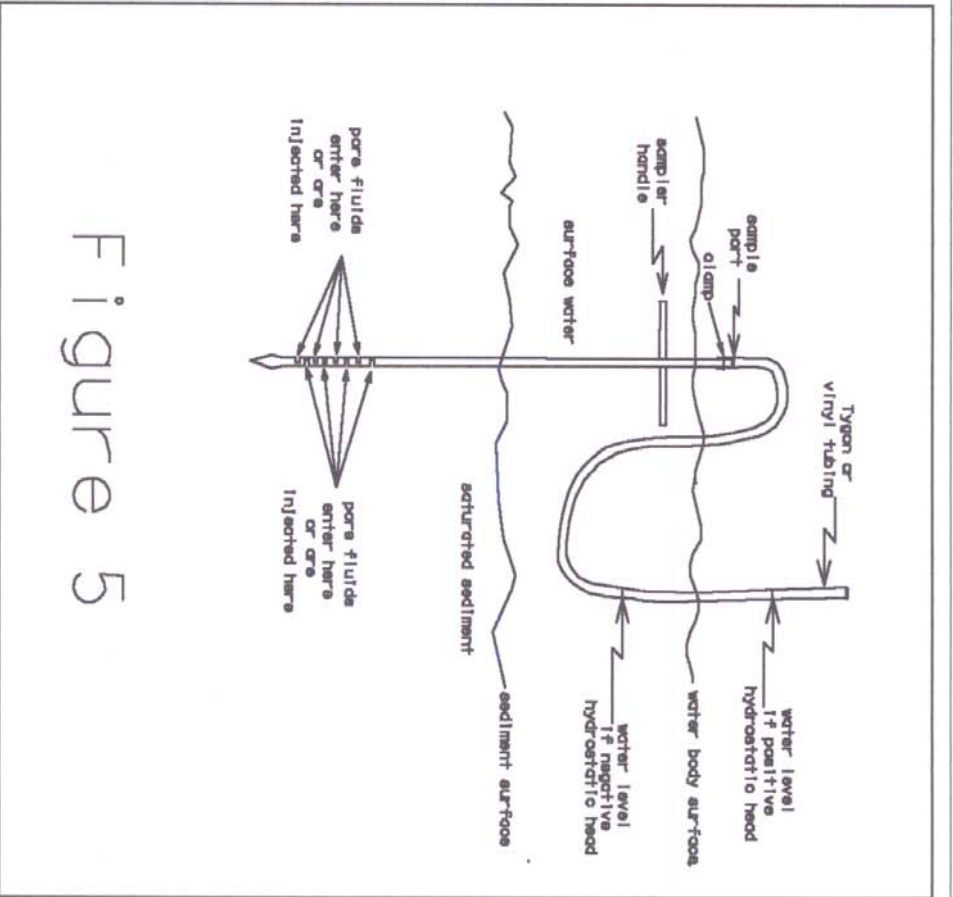

Figure 5

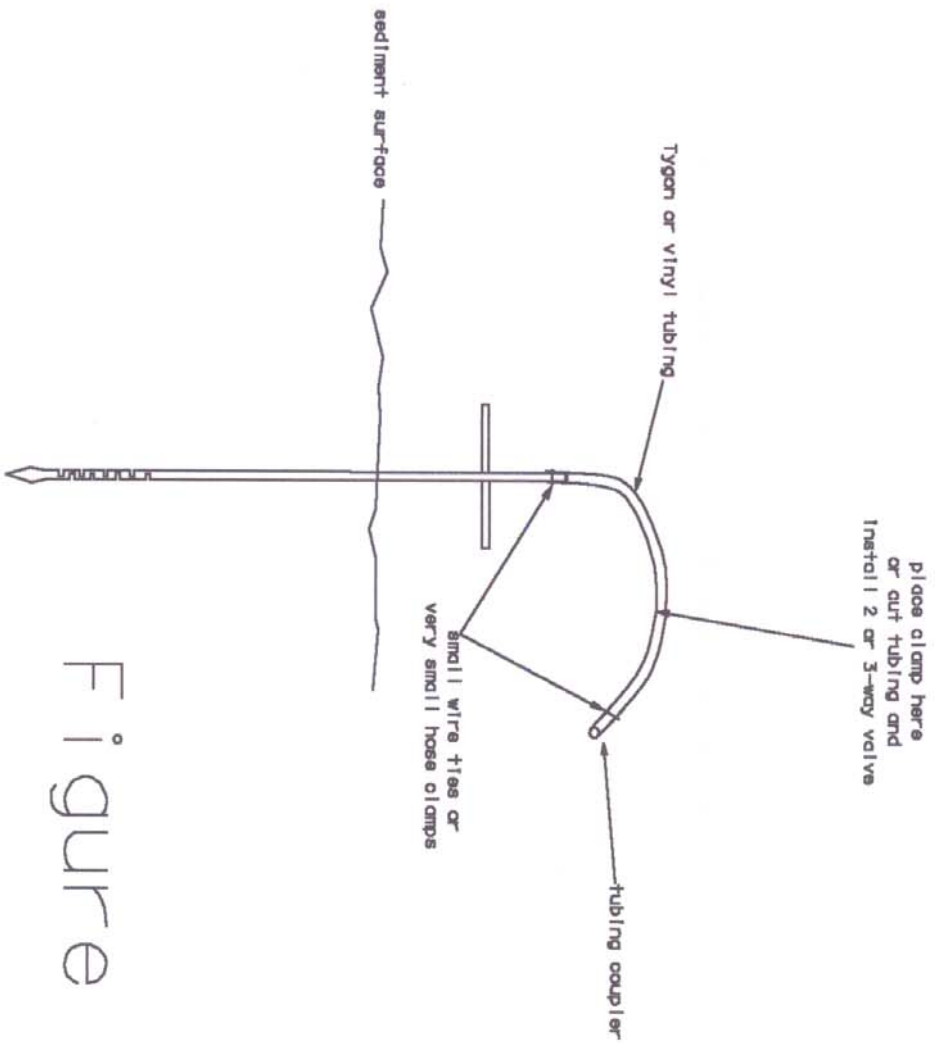
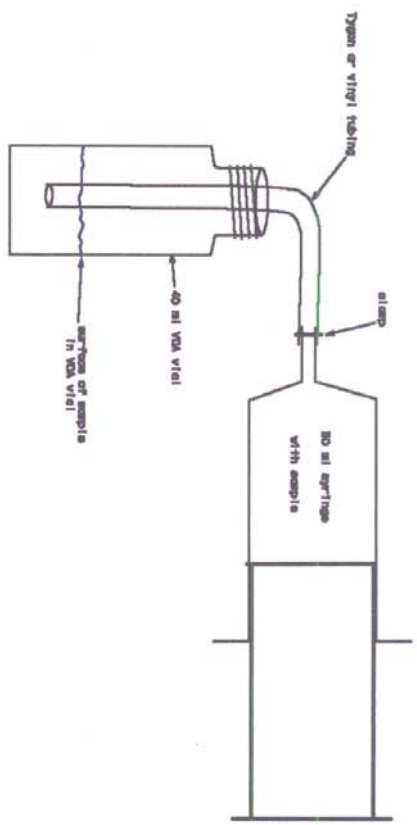

Figure 6

dispensing sample
into VOA vial



sample in VOA vial
awaiting preservation
and capping

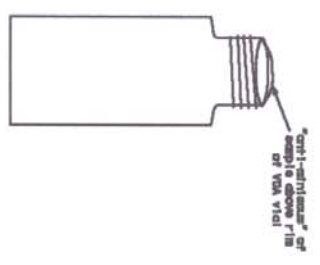

Figure 7
filling VOA vial "headspace free"

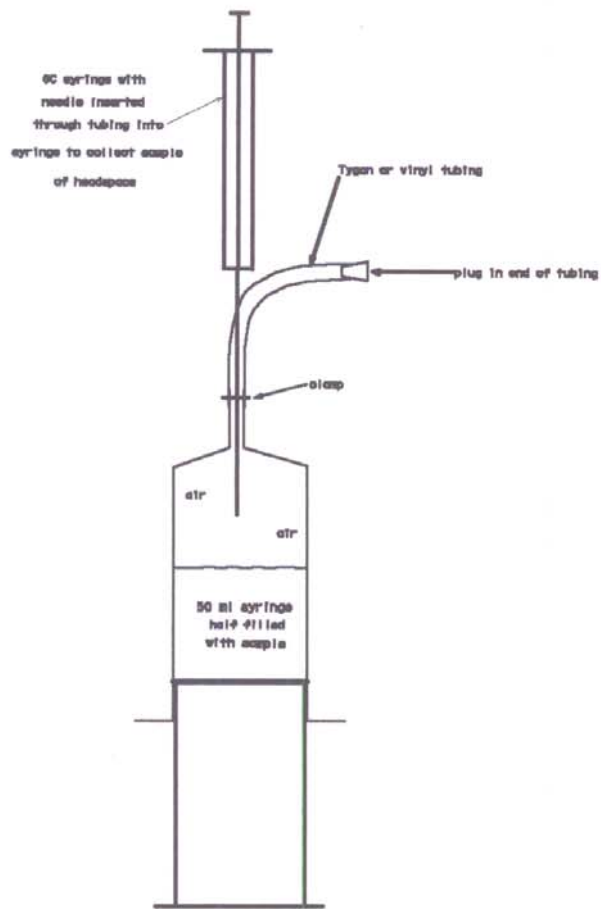

Figure 8